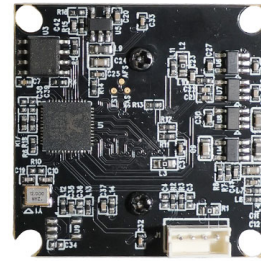

**YDS-USB-1635 V1****8.79MP 1635 Sony IMX166 M12 Fixed Focus USB 2.0 Camera Module**

YDS-USB-1635 V1 is an 8.79MP Fixed Focus USB camera module based on 1/3.2" IMX166 image sensor. It delivers high-speed, 4K resolution ultra sharp image.

The S-mount (M12) lens holder enables customers to choose different lens as per varies applications. This camera module is ideal solution for face recognition, identity detection, automotive, access control.

### Key Features

- 4K resolution (3576 x 2512) Sony IMX166 sensor
- High speed USB 2.0 Plug and Play
- MJPG and YUV2 output format
- Low power consumption
- Compact size
- UVC compliant to Windows, Linux, OS with UVC driver
- USB OTG (On-The-Go) support



# YDS CAMERA MODULE

*your best camera partner*

## YDS-USB-1635 V1

### 8.79MP 1635 Sony IMX166 M12 Fixed Focus USB 2.0 Camera Module

Camera Module No.	YDS-USB-1635 V1
Resolution	8.79MP
Image Sensor	IMX166
Sensor Type	1/3.2"
Pixel Size	1.4 um x 1.4 um
EFL	2.14 mm
F.NO	2.40
Pixel	3576 x 2512
View Angle	144°(DFOV) 126°(HFOV) 76°(VFOV)
Lens Dimensions	13.20 x 13.20 x 23.20 mm
Module Type	Fixed Focus
Lens Model	YDS-LENS-1635 V1
Interface	USB 2.0
Output Format	MJPEG / YUV2
Auto Control	Saturation, Contrast, Acutance White Balance, Exposure
Audio	Digital Microphone, Single, Dual Channel
Input Voltage	DC 5V
Working Current	Max 500mA
PCB Size	32 x 32 mm
System Compatibility	Windows XP (SP2, SP3), Vista, 7, 8, 10, 11 Android, Mac OS, Linux or OS with UVC Driver Raspberry Pi by USB Port
Software for USB Camera	AMCAP, Webcam Viewer, V4L2 Controls Contacam, VLC Player, MotionEye OS iSpy, ZoneMider, Yawcam
Lens Type	650nm IR Cut
Operating Temperature	-30°C to +70°C
USB Cable	YDS-Cable-U015

Wide Compatibility with Windows, Android, Mac OS, Linux, or Raspberry Pi



[www.YDSCAM.com](http://www.YDSCAM.com) [sales@ydscam.com](mailto:sales@ydscam.com) Phone (WeChat, QQ): (+86) 177 2732 6718

All rights reserved @ YingDeShun Co. Ltd. Specifications subject to change without notice.



## YDS-USB-1635 V1

### 8.79MP 1635 Sony IMX166 M12 Fixed Focus USB 2.0 Camera Module



Top View



Side View



Bottom View



Mating Connector

## YDS-USB-1635 V1

### 8.79MP 1635 Sony IMX166 M12 Fixed Focus USB 2.0 Camera Module

FORMAT	RESOLUTION	FRAME RATE
		USB 2.0
MJPEG	640 x 480 (VGA)	30 FPS
	1280 x 720 (720P)	30 FPS
	1920 x 1080 (1080P)	15 FPS
	2592 x 1944 (5MP)	15 FPS
	3264 x 2448 (8MP)	15 FPS
YUY2	640 x 480 (VGA)	30 FPS
	1280 x 720 (720P)	5 FPS
	1920 x 1080 (1080P)	2 FPS
	2592 x 1944 (5MP)	2 FPS
	3264 x 2448 (8MP)	2 FPS







# YDS CAMERA MODULE

*your best camera partner*



[www.YDSCAM.com](http://www.YDSCAM.com) [sales@ydscam.com](mailto:sales@ydscam.com) Phone (WeChat, QQ): (+86) 177 2732 6718

All rights reserved @ YingDeShun Co. Ltd. Specifications subject to change without notice.







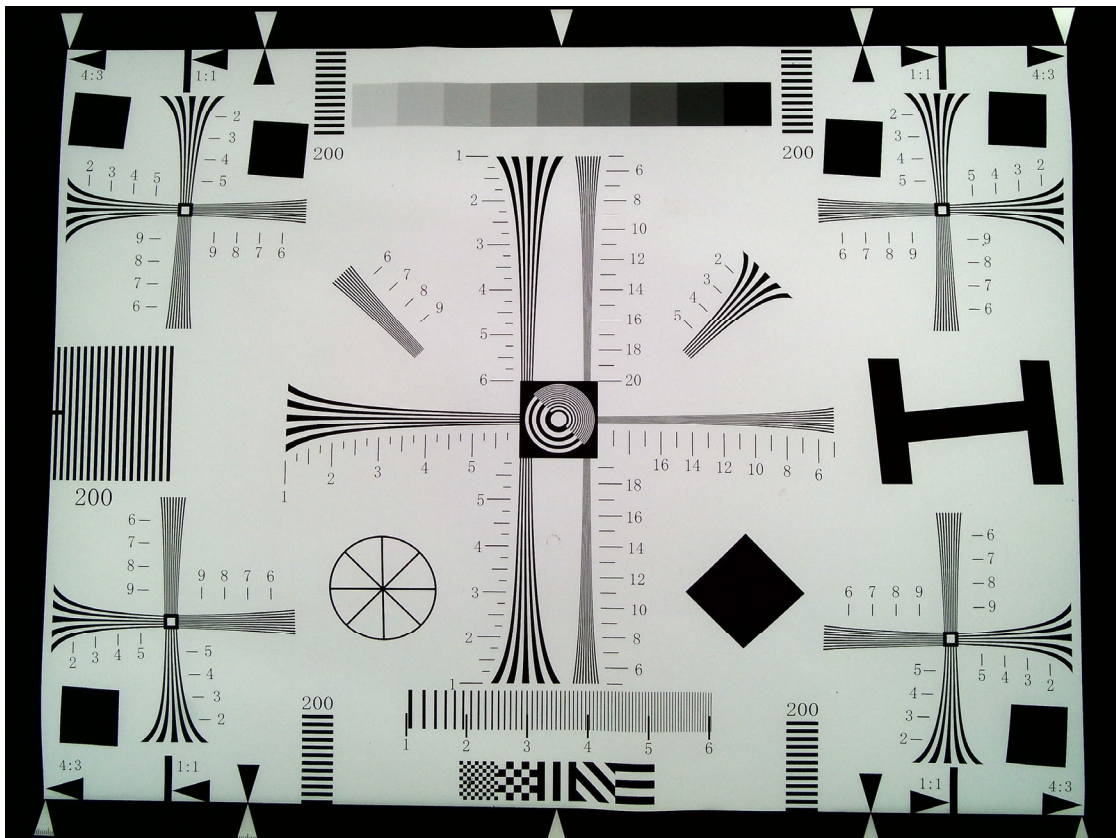



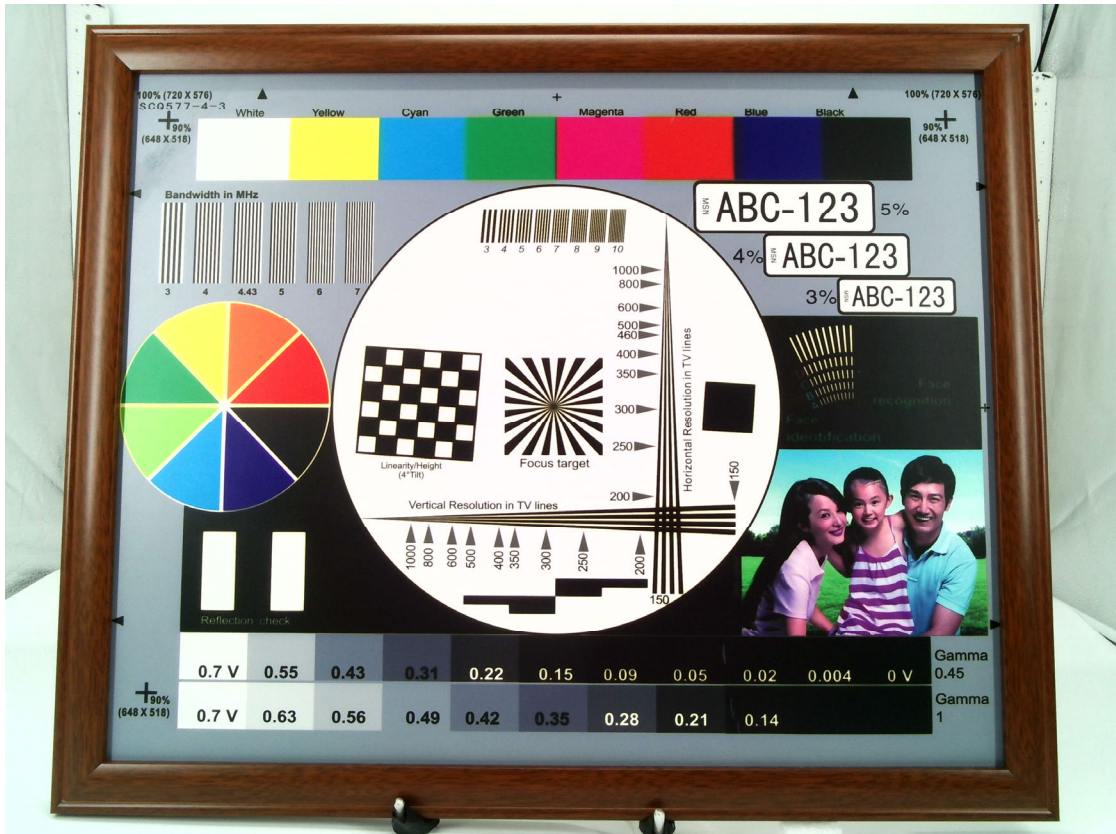
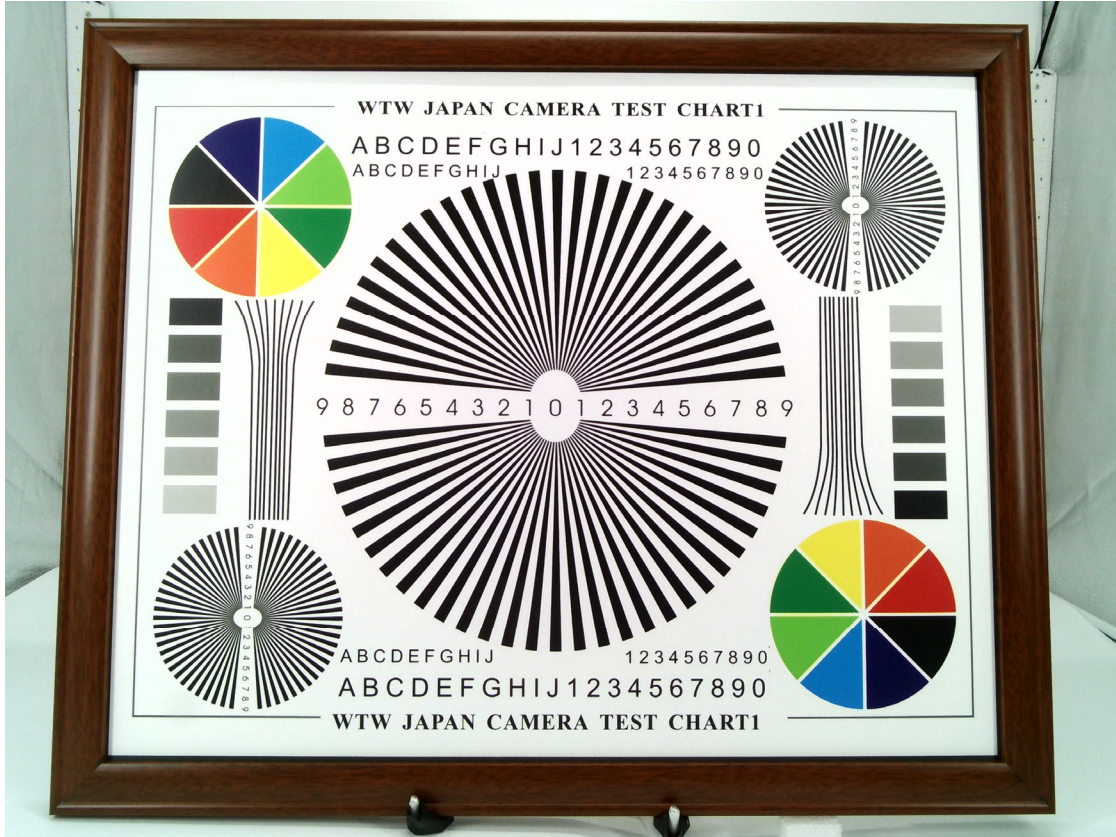



Version	Information	Date
V1.0	First Version	8-16-2022

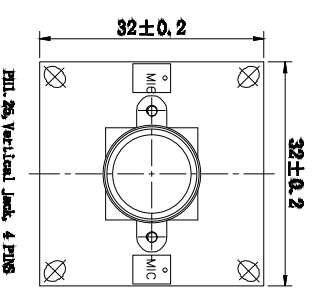
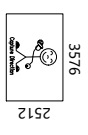

PHIL 265 Vertical Jack, 4 PINS

00000000	DP	DM	USB5V
J26	P4	P3	P2
			P1

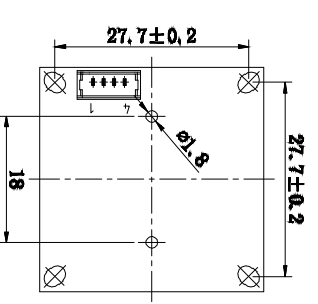
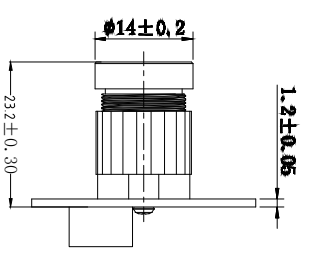

### TOP VIEW

### RIGHT VIEW

### BOTTOM VIEW

#### Parameters:

#### 1、Sensor specification:

Image Sensor: IMX166  
 Pixel: 1.4um×1.4um  
 Lens Type: 1/3.2  
 Important Voltage Description: USB 5V  
 (external power supply);

#### 2、Lens specification:

FOV: 144°(D);126°(H);76°(V)  
 F/NO: 2.4  
 TV distortion: <TBD  
 Focal length: 2.14mm  
 Composition: 4G2P+IR FILTER  
 IR Cut Coating: 650nm±10nm@50%

Designed By	Kevin	Model Name:	USB-1635 V1		
Checked By	Jacky	Projection Type:	Unit: mm	Material:	-----
		Third Angle	Scale: 1:1	Sheet: 1 of 1	Version: 1/0

Diagonal 6.1 mm (Type 1/3.2) CMOS Image Sensor with Square Pixel for Colour Cameras

# IMX166PQH5-C

## Description

The IMX166PQH5-C is a diagonal 6.1 mm (Type 1/3.2) CMOS active pixel type image sensor with a square pixel array and 8.79M effective pixels. This chip operates with three power supplies, analogue 2.7 V, digital 1.2 V, and IF 1.8 V, and has low power consumption. High sensitivity, low dark current, and no smear are achieved through the adoption of R, G, and B primary colour pigment mosaic filters. This chip features an electronic shutter with variable charge-storage time.

In addition, this product is designed for use in cellular phone. When using this for another application, Sony does not guarantee the quality and reliability of product.

Therefore, don't use this for applications other than cellular phone. Consult your Sony sales representative if you have any questions.

## Features

- ◆ CMOS active pixel type dots
- ◆ 2-wire serial communication circuit on chip
- ◆ CSI2 serial data output
- ◆ Timing generator, H and V driver circuits on chip
- ◆ CDS/PGA on chip
- ◆ 10-bit A/D converter on chip
- ◆ Automatic optical black (OB) clamp circuit on chip
- ◆ PLL on chip (rectangular wave/sine wave)
- ◆ High sensitivity, low dark current, no smear
- ◆ Excellent anti-blooming characteristics
- ◆ Variable-speed shutter function (1 H units)
- ◆ R, G, B primary colour pigment mosaic filters on chip
- ◆ Max. 45 frame/s in all-pixel scan mode
- ◆ Pixel rate: 398 MHz (All-pixel, 45 frame/s)



\* "Exmor R" is a trademark of Sony Corporation. The "Exmor R" is a Sony's CMOS image sensor with significantly enhanced imaging characteristics including sensitivity and low noise by changing fundamental structure of "Exmor" pixel adopted column parallel A/D converter to back-illuminated type.

Sony reserves the right to change products and specifications without prior notice.

This information does not convey any license by any implication or otherwise under any patents or other right.

Application circuits shown, if any, are typical examples illustrating the operation of the devices. Sony cannot assume responsibility for a problems arising out of the use of these circuits.





# YDS CAMERA MODULE

*your best camera partner*

## Camera Module Pinout Definition Reference Chart

OmniVision	Sony	Samsung	On-Semi	Aptina	Himax	GalaxyCore	PixArt	SmartSens	Sensors
Pin Signal		Description							
DGND	GND	ground for digital circuit							
AGND		ground for analog circuit							
PCLK	DCK	DVP PCLK output							
XCLR	PWDN	XSHUTDOWN	STANDBY	power down active high with internal pull-down resistor					
MCLK	XVCLK	XCLK	INCK	system input clock					
RESET	RST	reset active low with internal pull-up resistor							
NC	NULL	no connect							
SDA	SIO_D	SIOD	SCCB data						
SCL	SIO_C	SIOC	SCCB input clock						
VSYNC	XVS	FSYNC	DVP VSYNC output						
HREF	XHS	DVP HREF output							
DOVDD	power for I/O circuit								
AFVDD	power for VCM circuit								
AVDD	power for analog circuit								
DVDD	power for digital circuit								
STROBE	FSTROBE	strobe output							
FSIN	synchronize the VSYNC signal from the other sensor								
SID	SCCB last bit ID input								
ILPWM	mechanical shutter output indicator								
FREX	frame exposure / mechanical shutter								
GPIO	general purpose inputs								
SLASEL	I2C slave address select								
AFEN	CEN chip enable active high on VCM driver IC								
<b>MIPI Interface</b>									
MDN0	DN0	MD0N	DATA_N	DMO1N	MIPI 1st data lane negative output				
MDP0	DP0	MD0P	DATA_P	DMO1P	MIPI 1st data lane positive output				
MDN1	DN1	MD1N	DATA2_N	DMO2N	MIPI 2nd data lane negative output				
MDP1	DP1	MD1P	DATA2_P	DMO2P	MIPI 2nd data lane positive output				
MDN2	DN2	MD2N	DATA3_N	DMO3N	MIPI 3rd data lane negative output				
MDP2	DP2	MD2P	DATA3_P	DMO3P	MIPI 3rd data lane positive output				
MDN3	DN3	MD3N	DATA4_N	DMO4N	MIPI 4th data lane negative output				
MDP3	DP3	MD3P	DATA4_P	DMO4P	MIPI 4th data lane positive output				
MCN	CLKN	CLK_N	DCKN	MIPI clock negative output					
MCP	CLKP	MCP	CLK_P	DCKN	MIPI clock positive output				
<b>DVP Parallel Interface</b>									
D0	DO0	Y0	DVP data output port 0						
D1	DO1	Y1	DVP data output port 1						
D2	DO2	Y2	DVP data output port 2						
D3	DO3	Y3	DVP data output port 3						
D4	DO4	Y4	DVP data output port 4						
D5	DO5	Y5	DVP data output port 5						
D6	DO6	Y6	DVP data output port 6						
D7	DO7	Y7	DVP data output port 7						
D8	DO8	Y8	DVP data output port 8						
D9	DO9	Y9	DVP data output port 9						
D10	DO10	Y10	DVP data output port 10						
D11	DO11	Y11	DVP data output port 11						

[www.YDSCAM.com](http://www.YDSCAM.com) [sales@ydscam.com](mailto:sales@ydscam.com) Phone (WeChat, QQ): (+86) 177 2732 6718

All rights reserved @ YingDeShun Co. Ltd. Specifications subject to change without notice.

## Cameras Applications





## Camera Reliability Test

Reliability Inspection Item		Testing Method	Acceptance Criteria	
Category	Item			
Environmental	Storage Temperature	High 60°C 96 Hours	Temperature Chamber	No Abnormal Situation
		Low -20°C 96 Hours	Temperature Chamber	No Abnormal Situation
	Operation Temperature	High 60°C 24 Hours	Temperature Chamber	No Abnormal Situation
		Low -20°C 24 Hours	Temperature Chamber	No Abnormal Situation
	Humidity	60°C 80% 24 Hours	Temperature Chamber	No Abnormal Situation
	Thermal Shock	High 60°C 0.5 Hours Low -20°C 0.5 Hours Cycling in 24 Hours	Temperature Chamber	No Abnormal Situation
Physical	Drop Test (Free Falling)	Without Package 60cm	10 Times on Wood Floor	Electrically Functional
		With Package 60cm	10 Times on Wood Floor	Electrically Functional
	Vibration Test	50Hz X-Axis 2mm 30min	Vibration Table	Electrically Functional
		50Hz Y-Axis 2mm 30min	Vibration Table	Electrically Functional
		50Hz Z-Axis 2mm 30min	Vibration Table	Electrically Functional
	Cable Tensile Strength Test	Loading Weight 4 kg 60 Seconds Cycling in 24 Hours	Tensile Testing Machine	Electrically Functional
Electrical	ESD Test	Contact Discharge 2 KV	ESD Testing Machine	Electrically Functional
		Air Discharge 4 KV	ESD Testing Machine	Electrically Functional
	Aging Test	On/Off 30 Seconds Cycling in 24 Hours	Power Switch	Electrically Functional
	USB Connector	On/Off 250 Times	Plug and Unplug	Electrically Functional



## Camera Inspection Standard

Inspection Item		Inspection Method	Standard of Inspection		
Category	Item				
Appearance	FPC/ PCB	Color	The Naked Eye	Major Difference is Not Allowed.	
		Be Torn/Chopped	The Naked Eye	Copper Crack Exposure is Not Allowed.	
		Marking	The Naked Eye	Clear, Recognizable (Within 30cm Distance)	
	Holder	Scratches	The Naked Eye	The Inside Crack Exposure is Not Allowed	
		Gap	The Naked Eye	Meet the Height Standard	
		Screw	The Naked Eye	Make Sure Screws Are Presented (If Any)	
		Damage	The Naked Eye	The Inside Crack Exposure is Not Allowed	
	Lens	Scratch	The Naked Eye	No Effect On Resolution Standard	
		Contamination	The Naked Eye	No Effect On Resolution Standard	
		Oil Film	The Naked Eye	No Effect On Resolution Standard	
		Cover Tape	The Naked Eye	No Issue On Appearance.	
	Function	Image	No Communication	Test Board	Not Allowed
			Bright Pixel	Black Board	Not Allowed In the Image Center
Dark Pixel			White board	Not Allowed In the Image Center	
Blurry			The Naked Eye	Not Allowed	
No Image			The Naked Eye	Not Allowed	
Vertical Line			The Naked Eye	Not Allowed	
Horizontal Line			The Naked Eye	Not Allowed	
Light Leakage			The Naked Eye	Not Allowed	
Blinking Image			The Naked Eye	Not Allowed	
Bruise			Inspection Jig	Not Allowed	
Resolution			Chart	Follows Outgoing Inspection Chart Standard	
Color			The Naked Eye	No Issue	
Noise			The Naked Eye	Not Allowed	
Corner Dark			The Naked Eye	Less Than 100px By 100px	
Color Resolution			The Naked Eye	No Issue	
Dimension	Height	The Naked Eye	Follows Approval Data Sheet		
	Width	The Naked Eye	Follows Approval Data Sheet		
	Length	The Naked Eye	Follows Approval Data Sheet		
	Overall	The Naked Eye	Follows Approval Data Sheet		



## YDSCAM Package Solutions

YDS Camera Module



Complete with Lens Protection Film



Tray with Grid and Space



Place Cameras on the Tray



## YDSCAM Package Solutions

Full Tray of Cameras

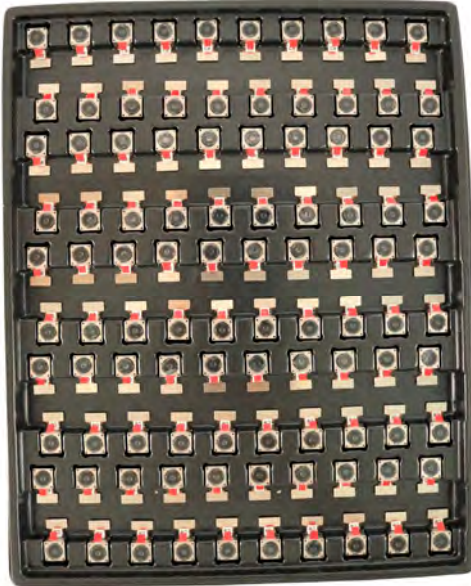

Cover Tray with Lid

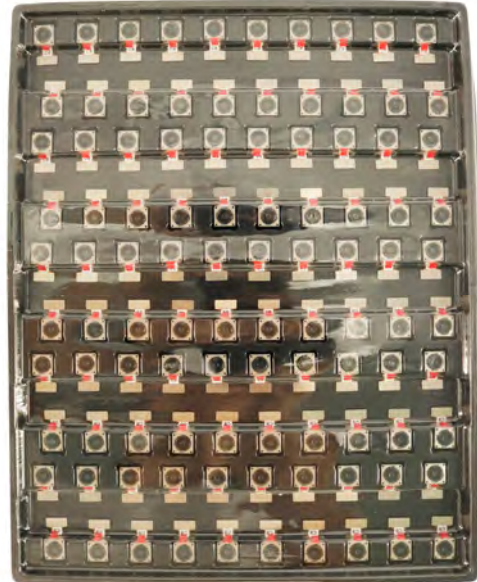

Place Tray into Anti-Static Bag



Vacuum the Anti-Static Bag





## YDSCAM Package Solutions

### Sealed Vacuum Anti-Static Bag with Labels

1. Model and Description 2. Quantity 3. Manufacturing Date Code 4. Caution



## YDSCAM Package Solutions

Place Foam Sheets Between Tray Bags



Foam Sheets are Larger Than Trays



Place Foam Sheets and Trays into Box



Foam Sheets are Tightly Fitting in Box



Seal the Carbon Box



Label the Carbon Shipping Box







## YDSCAM Package Solutions

USB Camera Module

Complete with Lens Protection Film



Place Camera Sample into Anti-Static Bag

Place USB Cameras into Tray



Seal the Tray with Anti-Static Bag

Label the Carbon Shipping Box



## YDSCAM Package Solutions

Place Camera Sample into Anti-Static Bag



Place Connectors into Anti-Static Bag



Label the Sample Bags



Place Connectors into Reel



Place Samples into the Carbon Box



Place Connectors into the Carbon Box







# YDS CAMERA MODULE

*your best camera partner*

## Company YDSCAM

YingDeShun Co. Ltd. (YDS) was established in 2017, a next-generation technology driven manufacturer specialized in research, design, and produce of audio and video products. YDS is occupying 20,000 square feet automated plants with 100 employees of annual throughput 30,000,000 units cameras.

YDS provides OEM, ODM design, contract manufacturing, and builds the camera products. You may provide the requirements to us, even with a hand draft, our sales and engineering work together to meet your needs. We consider ourselves your last-term partner in developing practical and innovative solutions.

Our team covers everything from initial concept development to mass produced product. YDS specializes in customized camera design, raw material, electronic engineering, firmware/software development, product testing, and packing design. Our experienced strategic supply systems offer a robust and dependable manufacturing capacity for orders of various sizes.

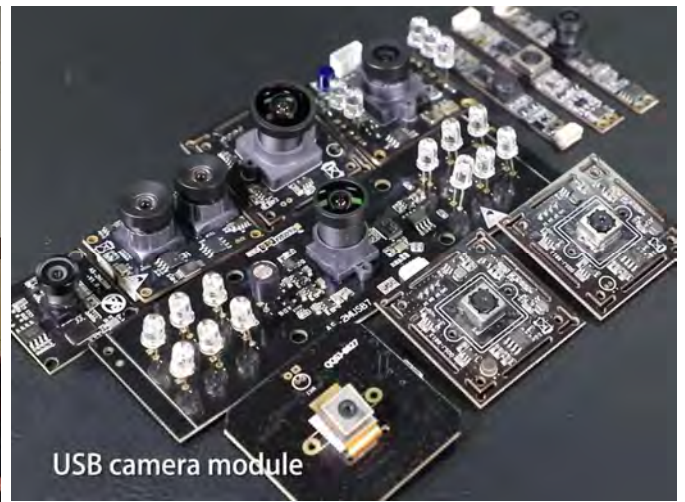

## Limited Warranty

YDS provides the following limited warranty if you purchased the Product(s) directly from YDS company or from YDS's website [www.YDSCAM.com](http://www.YDSCAM.com). Product(s) purchased from other sellers or sources are not covered by this Limited Warranty. YDS guarantees that the Product(s) will be free from defects in materials and workmanship under normal use for a period of one (1) year from the date you receive the product ("Warranty Period").

For all Product(s) that contain or develop material defects in materials or workmanship during the Warranty Period, YDS will, at its sole option, either: (i) repair the Product(s); (ii) replace the Product(s) with a new or refurbished Product(s) (replacement Product(s) being of identical model or functional equivalent); or (iii) provide you a refund of the price you paid for the Product(s).

This Limited Warranty of YDS is solely limited to repair and/or replacement on the terms set forth above. YDS is not reliable or responsible for any subsequent events.



[www.YDSCAM.com](http://www.YDSCAM.com) [sales@ydscam.com](mailto:sales@ydscam.com) Phone (WeChat, QQ): (+86) 177 2732 6718

All rights reserved @ YingDeShun Co. Ltd. Specifications subject to change without notice.





# YDS CAMERA MODULE

*your best camera partner*

## YDS Strength

### Powerful Factory



### Professional Service



### Promised Delivery



[www.YDSCAM.com](http://www.YDSCAM.com) [sales@ydscam.com](mailto:sales@ydscam.com) Phone (WeChat, QQ): (+86) 177 2732 6718

All rights reserved @ YingDeShun Co. Ltd. Specifications subject to change without notice.